

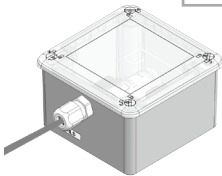

Quick Start GUIDE



Pulse Sens'O
50-70-160

Pulse Sens'O IP68
50-70-039



In'O
50-70-016
50-70-087

1

Démarrer Start

Vue de côté
Side view



Vue face
Front view



LEDs



Provisionner l'appareil sur votre réseau LoRaWAN® avec les clés mises à dispositions sur une plateforme sécurisée.

Provision the device on your LoRaWAN® network with the keys available on a secure platform.

ON

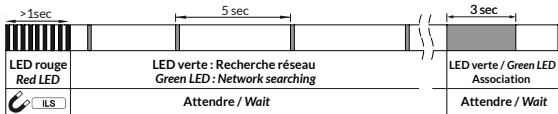

OFF

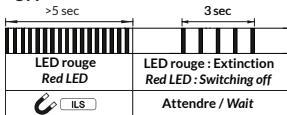

Vidéo / Video :
ON - OFF



<https://www.watteco.fr/assistance/tutoriels-video/>

2

Connectiques Connectors

In'O

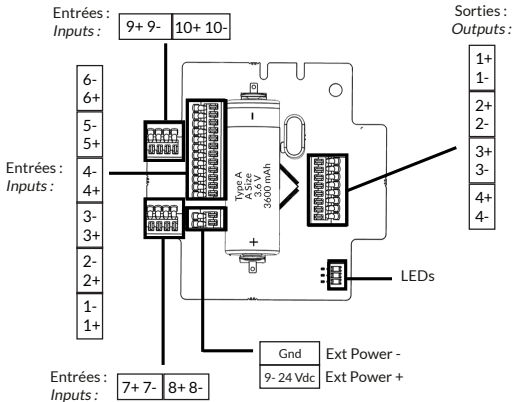

2

Connectiques Connectors

Pulse Sens'O

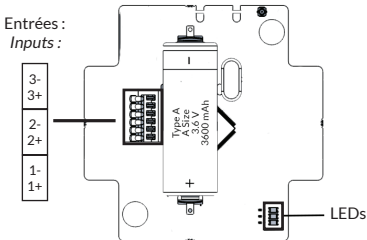

Pulse Sens'O IP68

Câble de couleur Wire Colour	Vert Green	Blanc White	Marron Brown	Rose Pink	Bleu Blue	Jaune Yellow
Connecteur Connector	Input 1+	Input 1-	Input 2+	Input 2-	Input 3+	Input 3-

2

Connectiques Connectors

Entrée / Input

Caractéristiques des 3 entrées : Characteristics of the 3 inputs:

- Impédance / Impedance: 1M Ω
- Tension : 0-30Vdc
- Courant délivré / Delivered current: 3.5 μ A
- Fréquence signal max / Signal frequency max: 0-100 Hz

Câblage (câble de section 20-26 awg) Wiring (20-26 swg stranded length):

- Suivant le type de sortie
- Depending on the type of output

Sortie contact sec isolé Isolated dry contact output

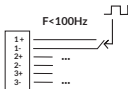

Sortie signal
Signal output

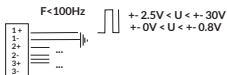

Sortie collecteur ouvert NPN NPN open collector output

F < 100Hz

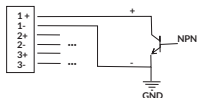

Compatible avec une tension 3V et un courant 3 μ A.
Compatible with 3V voltage and a 3 μ A current.

Pour les autres, il faut connecter une alimentation externe compatible et une résistance pour limiter le courant.

Others, need to connect a compatible external power supply and a resistor to limit the current.

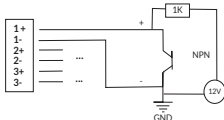

2

Connectiques Connectors

Sortie / Output

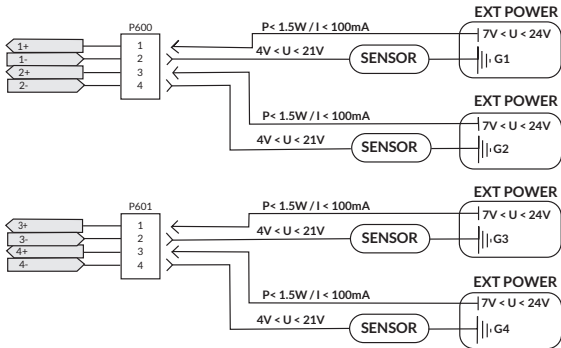

3

Installation Setting up

Ouverture / Fermeture
Opening / Closure

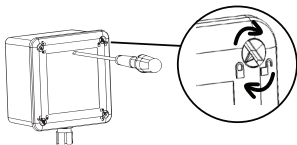

Montage mural
Wall mounting

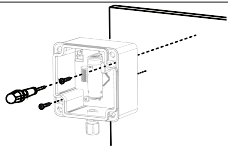
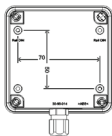

DIN

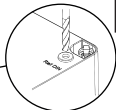
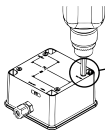

Foret $\varnothing 3,5$ mm
Drill $\varnothing 0.13$ in

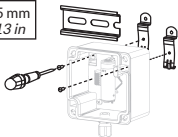

Attention, après mise en place du kit, l'indice de protection du boîtier passe en IP50.
Please note that after installation of the kit, the protection rating of the housing will change to IP50.

4

Propagation radioélectrique *Radio propagation*

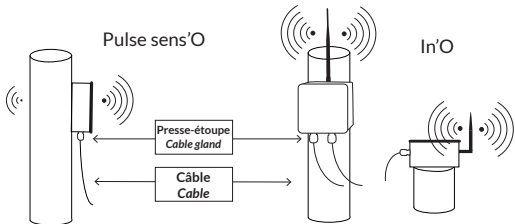

5

Caractéristiques / *Characteritics*

Référence / Reference	50-70-160	50-70-039	50-70-016	50-70-087
Classe / Class	A	A	A	C
Niveau de puissance / Power Level	+14 dBm	+14 dBm	+14 dBm	+14 dBm
Antenne / Antenna	Interne Internal	Interne Internal	Externe External	Externe External
Matériaux du boîtier / Casing materials	ASA / PC	ASA / PC	ASA / PC	ASA / PC
Indice de protection / IP rating	IP55	IP68	IP55	IP55



SITE SUPPORT

<https://support.watteco.com/>



CERTIFICATIONS

Watteco représenté par JC LE BLEIS, déclare que l'équipement radioélectrique du type 50-70-016/50-70-087/ 50-70-160/50-70-039 est conforme à la directive 2014/53/UE (RED). Le texte complet de la déclaration UE de conformité est disponible à l'adresse internet suivante: <https://www.watteco.fr/assistance/centre-de-telechargement/>

Watteco represented by JC LE BLEIS, declares that the radio equipment type 50-70-016/50-70-087/ 50-70-160/50-70-039 is in conformity with Directive 2014/53/EU (RED) and UKCA. The full text of the EU and UKCA Declaration of Conformity is available at the following web address: <https://www.watteco.com/assistance/download-center/>





WATTECO

IoT device manufacturer

**Merci d'avoir choisi
les produits WATTECO**

*Thanks for choosing
WATTECO devices*

